

**MICROPlumb®  
PRODUCTS  
Retrofit  
Flushometer  
Assemblies**

**MCR 274  
2.4-MOD64**



- ▶ **Description**  
Concealed electronic operated water closet Flushometer for retrofit of manual, handle-operated Flushometer.
- ▶ **Model Number/Flush Cycle**  
Model MCR-274-2.4-MOD64 Water Saver (2.4 gpf/9.0 Lpf)
- ▶ **Specifications**
  - Concealed electronic operated, diaphragm type, rough brass closet Flushometer
  - 24 VAC 50/60 Hz solenoid operator
  - 15' cord w/RJ-11 connection
  - Solenoid operator is reversible (can be located right or left of water supply)
  - Dual filtered Permex® bypass diaphragm
  - V-651-A Vac. Breaker repair kit
  - S-21 Gasket
- ▶ **Variations**

---

  - AG** Ground Joint Connection

---

  - LH** Left Hand

---

  - RH** Right Hand

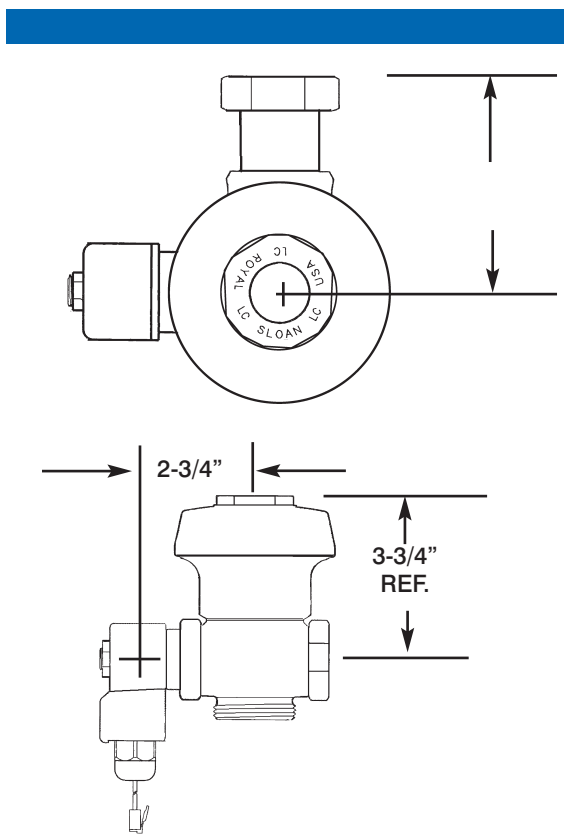

This space for Architect/Engineer approval

The information contained in this document is subject to change without notice.

